

- 
- 

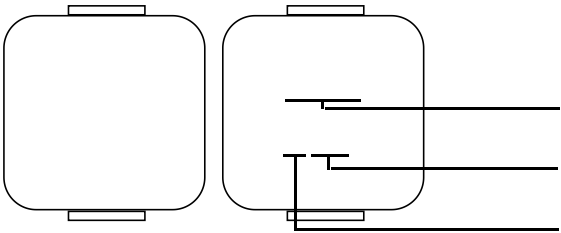

	$\mu$				

:

(      ),

(      )

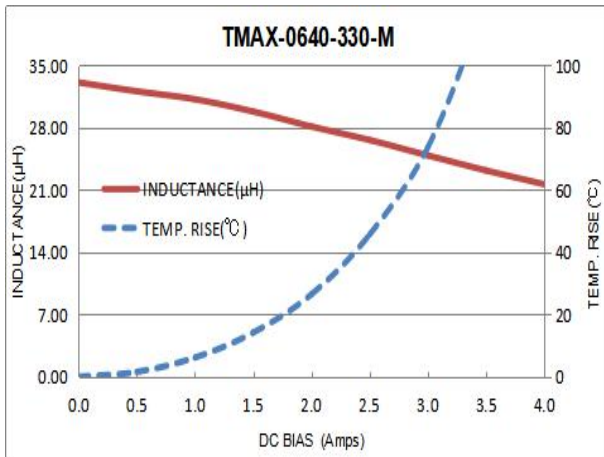
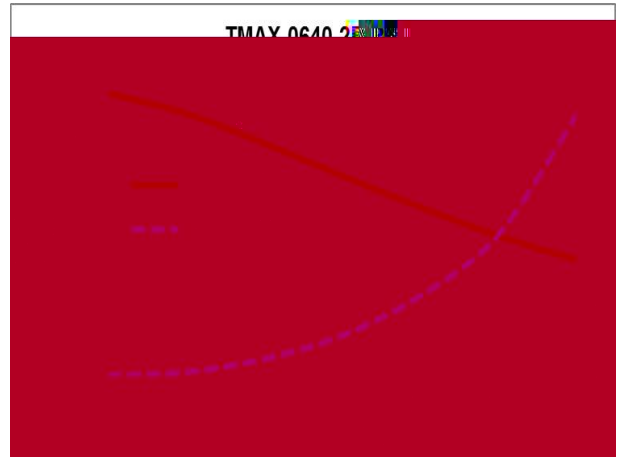
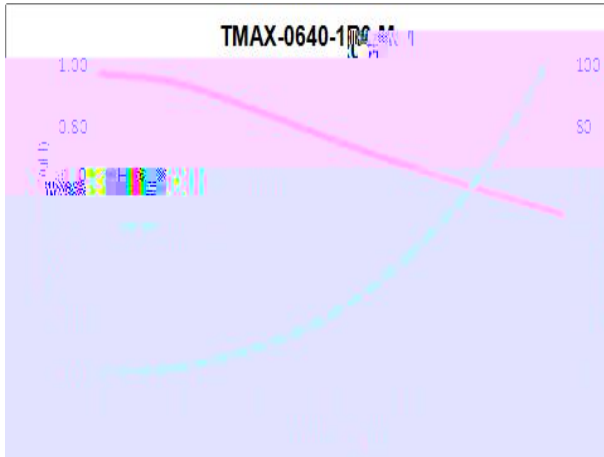

±  
± °C ±

±

---

	$\pm$ $\pm$ $\rightarrow$ $\rightarrow$ $\pm$ $\pm$ $\rightarrow$	
		$\pm$
		$\pm$
		$\pm$
		$\pm$
		$\pm$

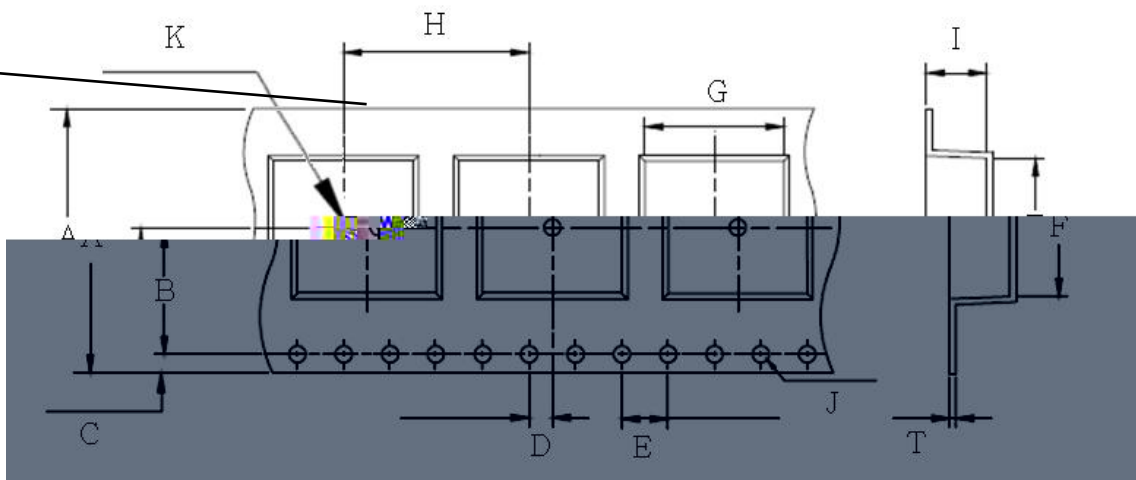

±	±	±	±	±	±
±	±	±	±	±	±

±	±	

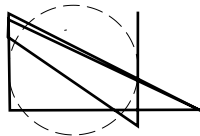

- 
- 

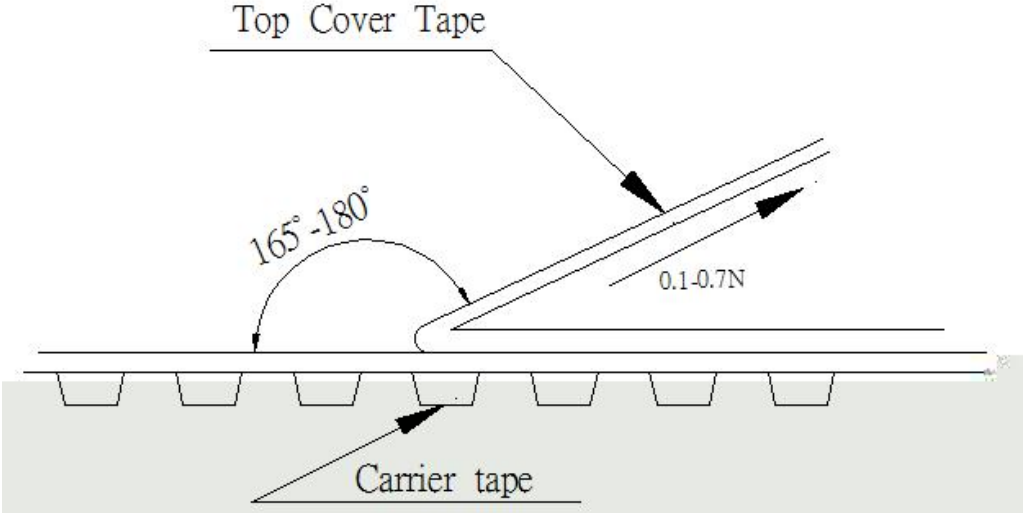



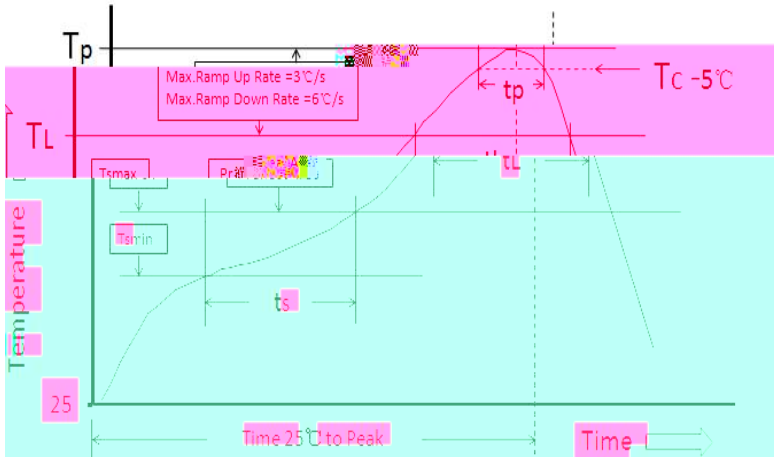

	<	≡
<	°C	°C
≡	°C	°C

	<		
<	°C	°C	°C
	°C	°C	°C
	°C	°C	°C

	°C	°C
	°C	°C
	°C	°C
	°C	°C
°C		
	°C	°C
°C		

●

●  
●

✓  
✓  
✓  
✓  
✓

✓  
✓  
✓  
✓  
✓

➤

➤  
✓  
✓

✓  
✓

➤

➤

